

Aplicação da 1ª camada na horizontal
Installing the 1st layer horizontally
Appliquer la 1ère couche horizontalement
Aplicación de la primera capa horizontal

62X (B4)*

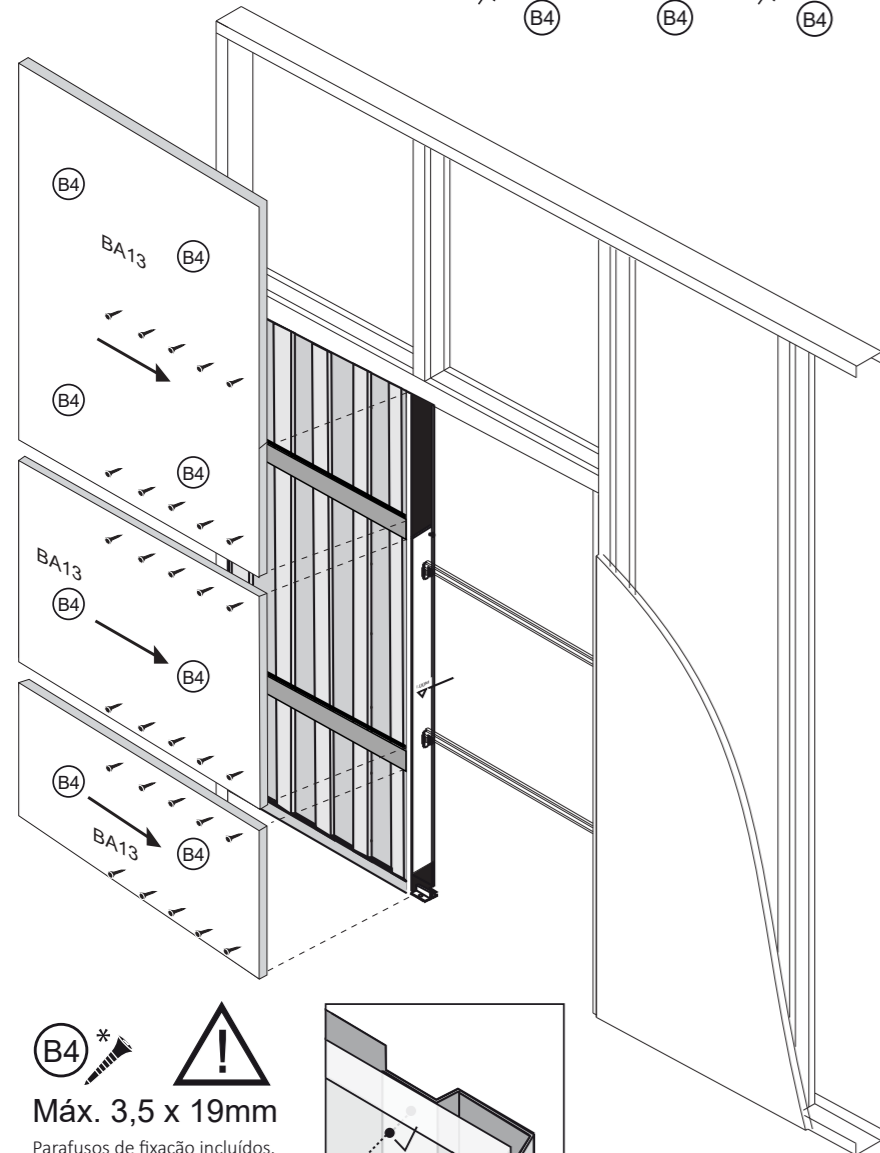

(B4)*
Máx. 3,5 x 19mm
Parafusos de fixação incluídos.
Fixing screws included.
Vis de fixation incluses.
Tornillos de fijación incluidos.

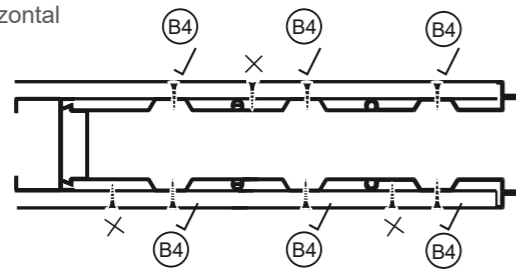
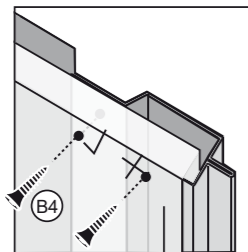

Aplicação da 2ª camada na Vertical
Installing of the 2nd layer vertically
Appliquer la 2ème couche dans le Vertical
Aplicación de la segunda capa en la vertical

52X (B5)*

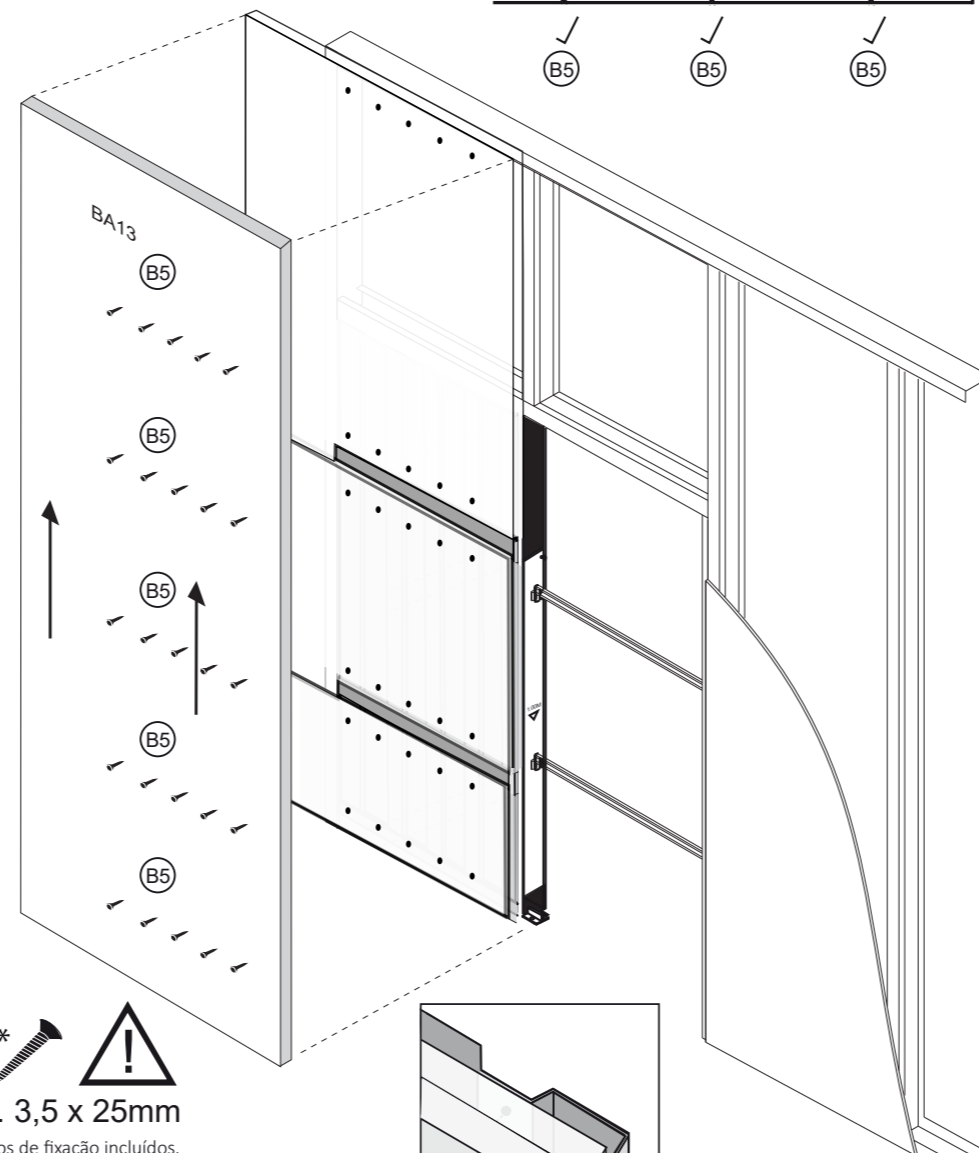
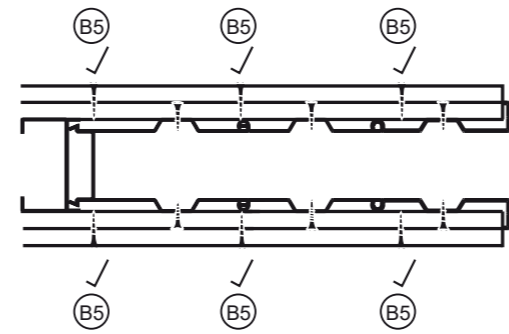

(B5)*
Máx. 3,5 x 25mm
Parafusos de fixação incluídos.
Fixing screws included.
Vis de fixation incluses.
Tornillos de fijación incluidos.

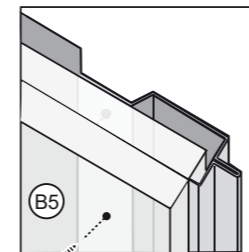

Finalização da aplicação
Finishing installation
Finir l'application
Finalización de la aplicación

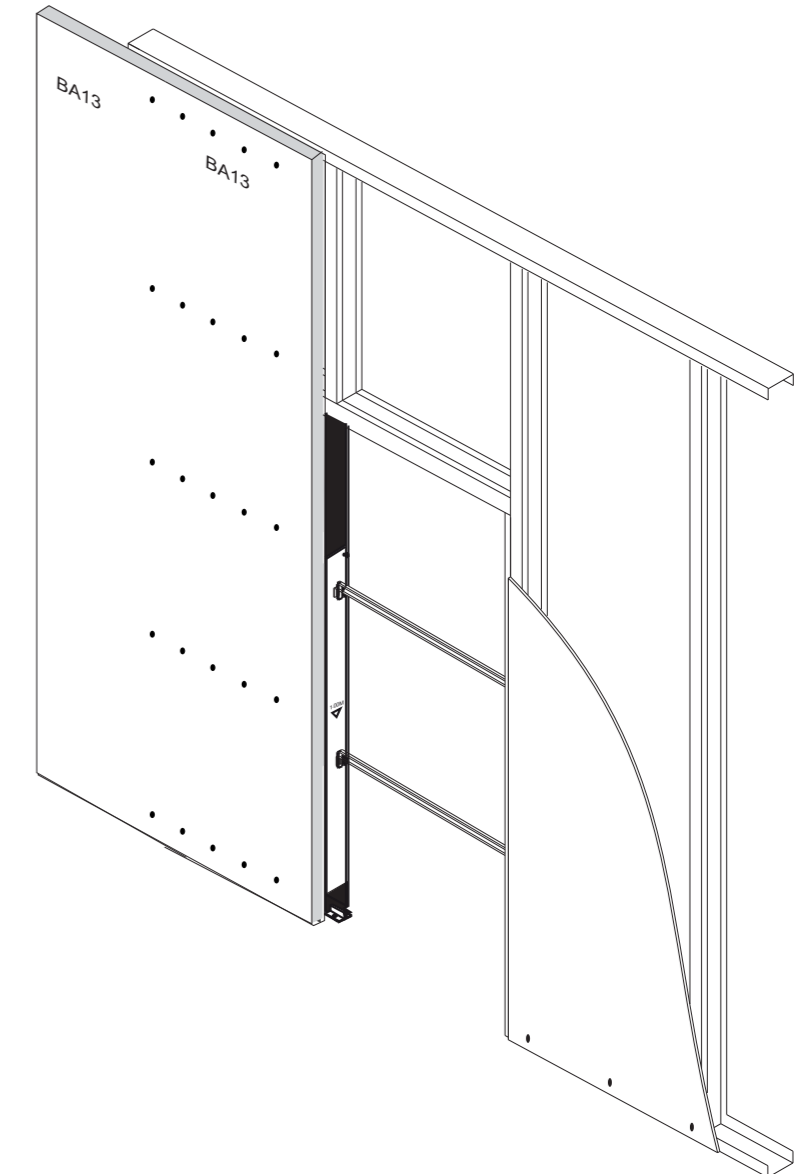
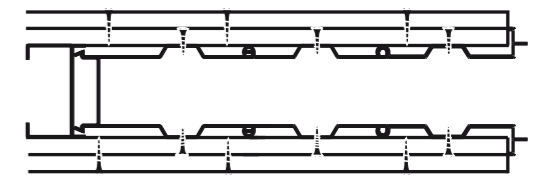

Atenção

Aplicável a todos os caixilhos com dimensões iguais ou superiores a 900mm de largura e 2200mm de altura. É obrigatório colocar 2 camadas de gesso cartonado sobre cada lateral do caixilho.

Warning

Applicable to all pocket frames with dimensions equal to or greater than 900mm width and 2200mm height. It is required to install 2 plasterboard sheets on each side of the frame.

Attention

Applicable à tous les contrechâssis des dimensions égales ou supérieures à 900mm de large et 2200mm de haut. Il est obligatoire de poser 2 plaques de plâtre de chaque côté du contrechâssis

Advertencia

Aplicable a todos los marcos con dimensiones iguales o superiores a 900 mm de ancho y 2200 mm de altura. Es obligatorio colocar 2 capas de cartón yeso sobre cada lateral del marco.

6

2x Porta | Door | Porte | Puerta

$$LP = \frac{LV}{2} - 2.5 \quad HP = H - 30$$

* 1x Placa de acabamento
(não fornecida)

$$LM = 95 \quad HM = HP$$

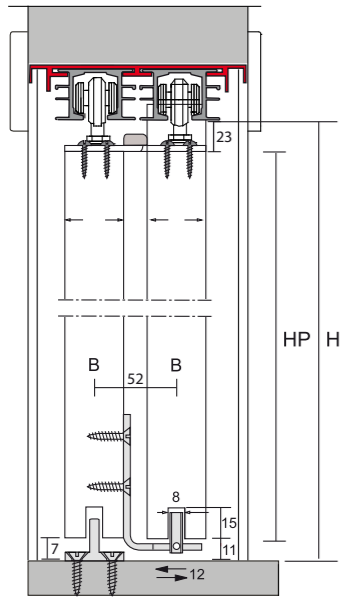

7

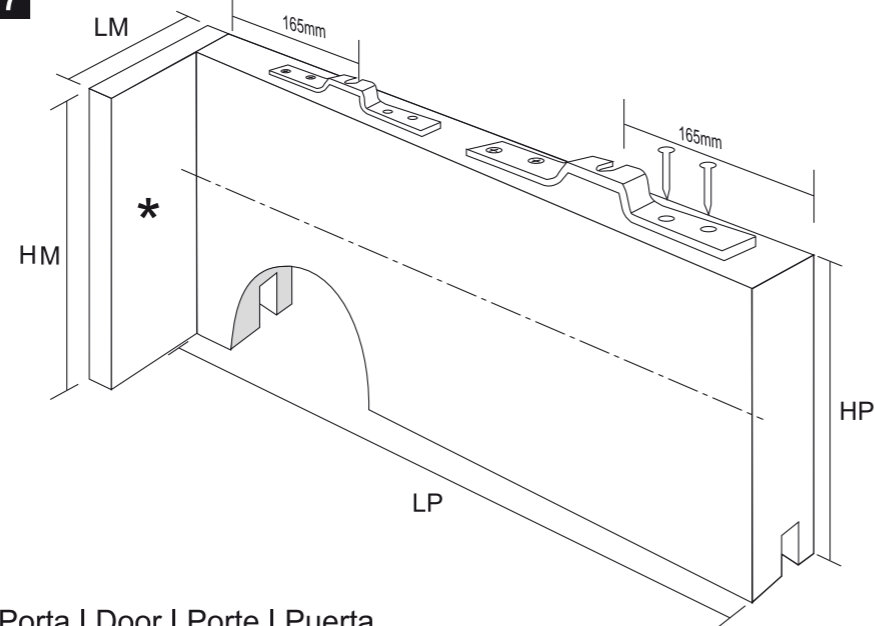

Porta | Door | Porte | Puerta

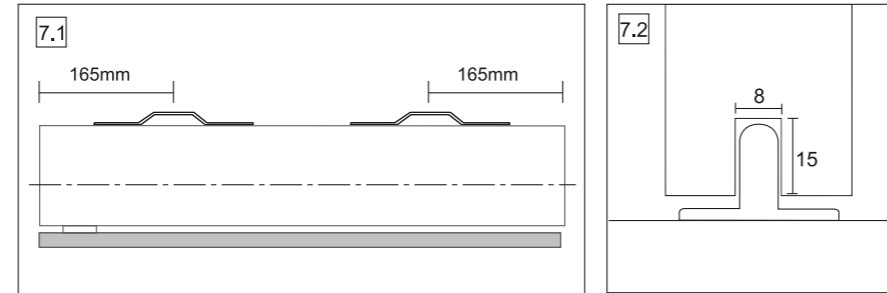

8

C6 1x Kit P1
Direita | Right | Droite | Derecha

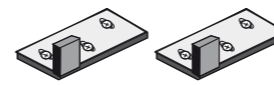

C6 1x Kit P2
Esquerda | Left | Gauche | Izquierda

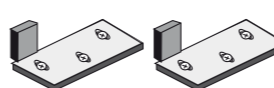

C7 1x

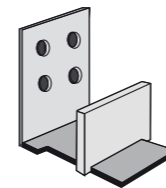

C8 6x C9 4x

C6 P1 Direita | Right | Droite | Derecha

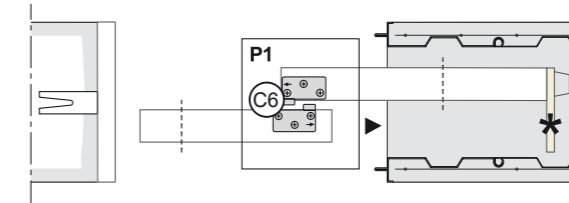

C6 P2 Esquerda | Left | Gauche | Izquierda

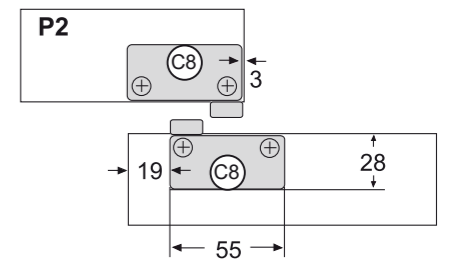
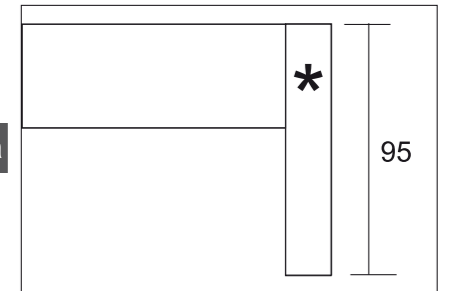
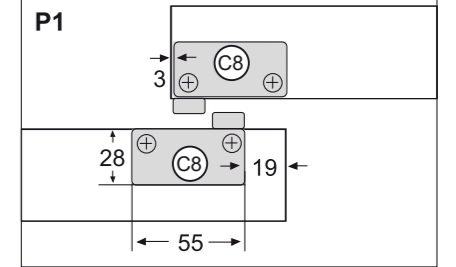
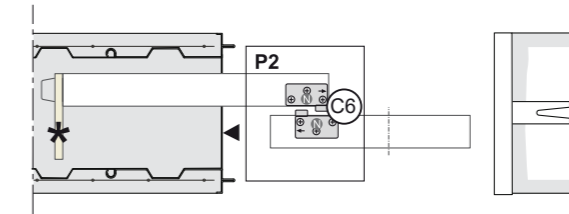

9

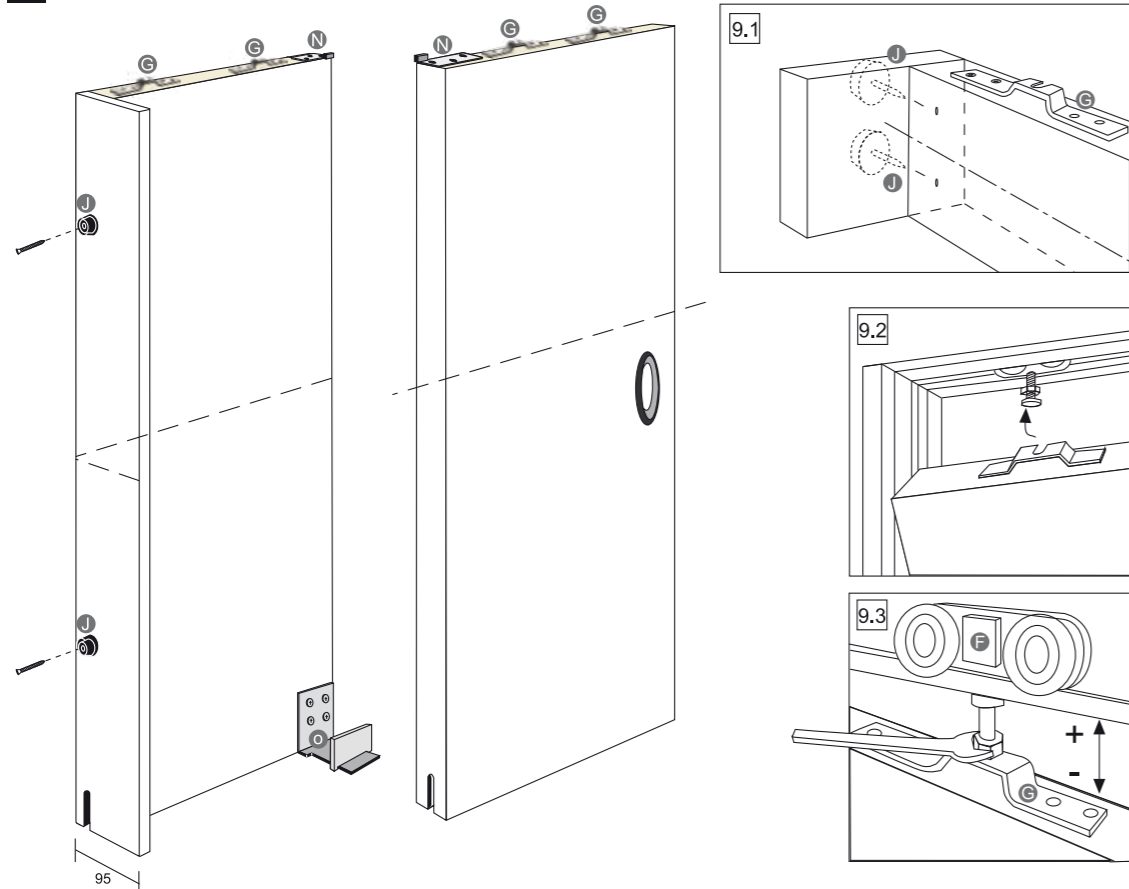

10

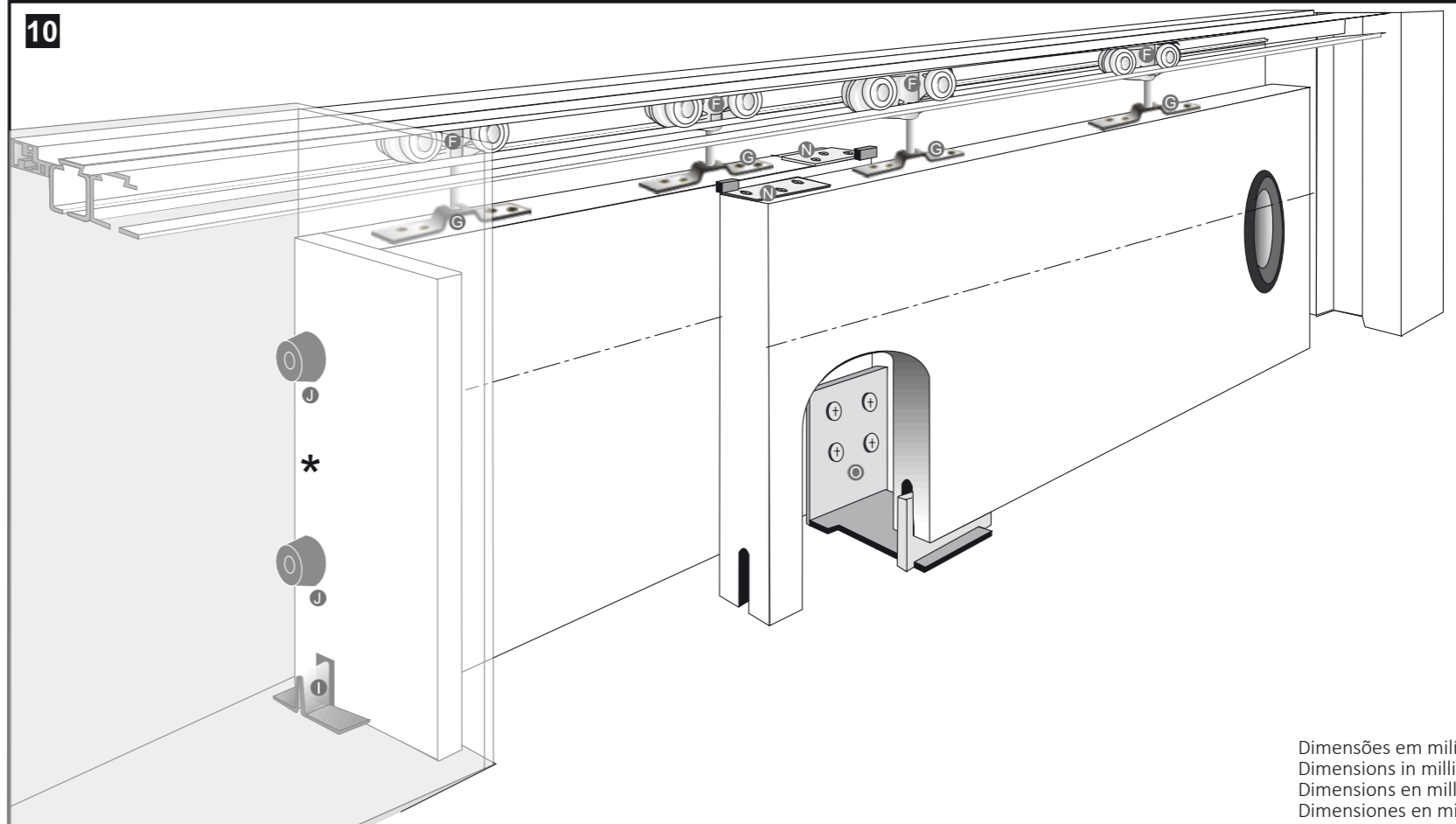

Dimensões em milímetros
Dimensions in millimeters
Dimensions en millimètres
Dimensiones en milímetros